



LAGUNA

151-PFlux3Tv2

IGM LAGUNA PFlux 3 mod.2022 Cyclone Dust Collector 400V

Manual



Producer

Laguna Tools Inc.

744 Refuge Way, Suite 200 Grand Prairie, Texas 75050

USA

Phone: +1 800-234-1976

Website: www.lagunatools.com

Distributor

IGM nástroje a stroje s.r.o.

Ke Kopanině 560, 252 67, Tuchoměřice

Czech Republic, EU

Phone: +420 220 950 910

E-mail: sales@igmtools.com

Website: www.igmtools.com

2026-06-22

151-PFlux3Tv2 LAGUNA Cyclone Dust Collector Manual EN v6.02.01 A4ob
VZOR_Návod k obsluze STROJ EN v1.00.00



PDF ONLINE
www.igmtools.info



EN – English Manual

Dear customer,

thank you for the confidence you have placed in us with the purchase of your new Laguna machine from IGM. This manual was prepared for the owner and operator of **IGM LAGUNA PFlux 3 mod.2022 Cyclone Dust Collector 400V** to promote safety during setup, operation and maintenance. Please read carefully and understand the information contained in this manual and accompanying documents. To obtain maximum service life and performance, use the machine according to these instructions and safety guidelines. Observe work safety.

We wish you a lot of work satisfaction and joy when working with the IGM LAGUNA PFlux 3 mod.2022 Cyclone Dust Collector 400V.

Contents

1. Declaration of Conformity
 - 1.1 Warranty
2. Product Specifications
3. Safety
 - 3.1 Intended Use
 - 3.2 General Safety Instructions
 - 3.3 Symbols
 - 3.4 Additional Instructions for Dust Collectors
 - 3.5 Power Supply
 - 3.6 Environment
4. Machine Description
 - 4.1 Package Contents
 - 4.2 Parts Description
5. Setup
 - 5.1 Unpacking
 - 5.2 Assembly
 - 5.3 Operation
6. Maintenance and Inspection
 - 6.1 Emptying the Drum
 - 6.2 Emptying the Filter End Cap
 - 6.3 Cleaning the HEPA Filter
 - 6.4 Replacing the HEPA Filter
7. Accessories
8. Troubleshooting
9. Wiring
10. Parts List

1. Declaration of Conformity



EC DECLARATION OF CONFORMITY

According to the following EC Directives

- Machinery Directive: 2006/42/EC
- Low Voltage Directive: 2014/35/EU



The applicant: LAGUNA TOOLS, INC./ 744 Refuge Way, Suite 200, Grand Prairie, Texas 75050 USA

Manufacturer: SAN FORD MACHINERY CO., LTD./ No.169, Chung shan Rd., FengYuan Dist., Taichung City 420, Taiwan (R.O.C.), Taiwan, manufacturer, declares that the machine described hereafter:

DUST COLLECTOR MODEL:

BFLUX1, CFLUX1, PFLUX1, CFLUX2, PFLUX2, CFLUX3, PFLUX3, TFLUX5, TFLUX10, XFLUX10, SFLUX10, AFLUX12, 820680, 821200

Provided that it is used and maintained in accordance with the generally accepted codes of good practice and the recommendations of the instructions manual, meets the essential safety and health requirements of the Machinery Directive.

The person who compile technical file established within the EU:

Name: IGM nastroje a stroje s.r.o.

Address: Ke Kopanine 560, Tuchomerice, CZ-252 67

Tel.: +420 220 950 910

Email: sales@igmtools.com

The TCF (No. SF-2024003-A1) is archived by CEPROM S.A. located in Str. Fântânele f.n., 440240 Satu Mare, judetul Satu Mare, Romania.

For the most specific risks of this machine, safety and compliance with the essential requirements of the Directive has been based on elements of:

- **EN ISO 12100:2010 / Safety of machinery - General principles for design - Risk assessment and risk reduction (ISO 12100:2010)**
- **EN 60204-1:2018 / Safety of machinery - Electrical equipment of machines- Part 1: General requirements- Industrial electrical device.**



Date: May 20, 2024

Authorized Signature:

Position: Chief Executive Officer

Place: Laguna Tools Inc.

744 Refuge Way, Suite 200, Grand Prairie, Texas 75050, USA

1.1 Warranty

IGM always strives to deliver a high-quality and efficient product. The warranty is governed by the valid terms and conditions of IGM.

2. Product Specifications

Machine Dimensions (LxWxH):	1168 x 686 x 2286 mm
Machine Weight:	175 kg
Package Dimensions (LxWxH):	1300 x 800 x 1300 mm
Package Weight:	200 kg
Noise Level:	76 dB
Motor:	2200 W
Power:	400 V / 50 Hz / 3 Phase
Recommended Breaker:	16 A, tripping characteristic C (16/3/C)
Airflow (traditional method):	3831 m ³ /hour (2253 CFM)
Airflow (realistic method):	2209 m ³ /hour (1299 CFM)
Max. Static Pressure:	2800 Pa
Fan Diameter:	390 mm
Inlet Diameter:	1x 200 mm or 3x 100 mm
Switch:	High-frequency remote control switch
Drum Volume:	174 l
Filter:	HEPA - 99.2 % of particles over 0,4 microns
Filtered Area:	9,5 m ²
Filter Dimensions:	diameter 400 mm x height 900 mm
Filter Waste Bag:	660 x 620 mm
Drum Waste Bag:	1194 x 960 mm

3. Safety

Proper use includes compliance with the instructions given in this manual and general regulations applicable in your country. The operator is liable for any use in violation of the intended use.

3.1 Intended Use

The machine is designed for collecting chips and sawdust from wood and woodworking machines. Collection of any other materials is prohibited.







3.2 General Safety Instructions

Warning! Read all instructions and safety guidelines. Failure to follow safety instructions may result in damage to the machine and serious injury to the operator. Keep the manual for future reference.

- The machine may be dangerous if not used properly.
- The machine may be operated only by a person familiar with the contents of this manual and machine operation.
- Keep children and pets away from packaging materials supplied with this machine.
- Place the machine on a stable and well-lit surface. There must be sufficient space around the machine for safe operation.
- Check the technical condition of the machine before operation. The machine may be used only in a perfect technical condition. If you notice any defects, do not start the machine and have it repaired by a qualified person.
- Replace damaged parts immediately. Use only original spare parts.
- All safety covers must be mounted before operation. Replace damaged covers immediately.
- The machine may be used, assembled, and maintained only by persons familiar with its operation and aware of potential danger. No changes to the machine may be made!
- Carry out maintenance regularly.
- Keep the machine and the surrounding area clean and well-lit. Remove all tools from the machine and surroundings before starting the machine.
- Carry out assembly, repairs and maintenance only when the machine is disconnected from the power supply.
- Prevent unintentional start of the machine. Before connecting the machine to the power supply, make sure the switch is in the OFF position.
- Make sure the circuit requirements specified in this manual are met.
- Take care of your safety when operating the machine. Long hair, loose clothing and jewellery may cause injury. Wear suitable work clothing, footwear, head, eye, ear and respiratory protection.
- Do not use gloves when operating the machine.
- Do not operate the machine if you are tired, ill or under the influence of drugs or alcohol.
- Watch your hands and fingers. Always use both hands when working.
- Do not lean over the machine. Always maintain balance and stand on a firm and stable surface when working.
- Keep children and other persons from moving freely around the workplace. Keep the machine out of reach of children and unqualified persons. Do not allow anyone unfamiliar with the machine and this manual to operate the machine.

- Never leave a running machine unattended. After you finish your work, turn off the machine and disconnect it from the power supply.
- Do not leave the machine in a damp environment and do not expose it to rain.
- Do not overload the machine.
- Do not operate the machine near flammable liquids or gases.
- Keep the motor fan clear.

3.3 Symbols

	Read the manual and all instructions carefully before use.
	Wear head, ear, eye and respiratory protection.
	Disconnect the machine from the power supply.
	Scan the QR code to find the manual.
	CE mark: The product is in compliance with EEA directives.
	Do not dispose of the appliance in the municipal waste.
	Recycle package materials.

3.4 Additional Instructions for Dust Collectors

Caution! Dust containing harmful chemicals such as lead from lead-based paints or arsenic and chromium from chemically treated lumber can be produced during operation. Work in a well-ventilated area and wear approved protective equipment. Observe safety regulations applicable in your country.

- Wear eye and respiratory protection when operating and maintaining the machine.
- Dispose of waste (dust and chips) following local regulations applicable in your country.
- Make sure the casters are locked before turning the machine on.
- Do not place your hands or tools near the air intake.
- Collect intended material only. If you accidentally use wood containing metal scraps (nails, staples etc.), stop working and turn the machine off immediately. Empty the drum (bag) and check the condition of the machine.
- Regularly check the waste level in the drum (bag). Empty if necessary.

3.5 Power Supply

Warning! Any modification to the electrical installation may be carried out only by a qualified electrician in accordance with all applicable regulations.

Warning! Do not connect the machine to the power supply until it is ready for operation.



Circuit Requirements

Warning! These requirements apply to a dedicated circuit where only one machine runs at a time. Consult a qualified electrician before connecting the machine to a shared circuit. Make sure the circuit is properly sized for safe operation.

This machine is designed to operate on a grounded power supply. The power circuit includes all electrical appliances between the machine and the breaker box or fuse panel in the building. The power circuit used for this machine must be sized to safely handle a full load current for an extended time.

Grounding and Plug Requirements

Caution! Improper grounding and connection of the machine to the power supply may result in an electric shock, damage or fire.

This machine is equipped with a grounded power cord. Insert the plug only into a matching outlet that is properly installed and grounded in accordance with all local regulations. Do not modify the provided plug!

Do not use the machine if the power cord or plug is damaged. All repairs may be carried out only by a qualified electrician!

3.6 Environment

Do not dispose of the appliance in the municipal waste. Electronic appliances must be collected and handed in for proper recycling. Recycle package material and other accessories. Observe safety regulations applicable in your country.



4. Machine Description

Carefully observe the images below and familiarize yourself with the package contents and listed machine parts and features.

4.1 Package Contents



- A. Motor
- B. Remote control + manual
- C. Dust chute
- D. Filter shield (front and back)
- E. Top upright supports (3x)
- F. Filter cover
- G. Drum insert (4x)
- H. HEPA Filter
- I. Rotation shaft
- J. Rotation paddle (2x)
- K. Crossbar
- L. Drum waste bag (3x)
- M. Cyclone funnel
- N. Cyclone barrel
- O. Intake cylinder
- P. Front and back drum panel
- Q. Drum lid
- R. Handle for drum lifting
- S. Filter end cap
- T. Drum base panel
- U. Lower upright supports (3x)
- V. Drum side plate (left and right)
- W. Upright support reinforcement plate (3x)
- X. Right and left bar for lifting mechanism
- Y. Accessories to install the lifting mechanism
- Y1. Lower triangular support plate (2x)
- Y2. Lifting mechanism support (2x)
- Y3. Lower cover plate (2x)

- AB. Inlet adaptor (3 openings)
- AC. Autoclean plate
- AD. Hardware

4.2 Parts Description

Control panel

A. HEPA filter detection

Illuminates when filter cleans (automatic cleaning/manual activation).

B. Drum illumination switch

Controls the LED light on the drum lid to illuminate inside the drum for visuals of the dust level.

C. Control panel pair button

Used to pair remote control with the machine.

D. Full drum detection

When the drum is full, the machine beeps continuously and the indicator light illuminates. When the drum is close to 70-80% full, the machine beeps intermittently.

E. ON/OFF switch

Turns the collector on or off.

F. On board circuit breaker

Pops out if the machine is overloaded. Allow the machine to cool down for a few minutes. Then press the reset button.

G. Manual activation

Press for 3 seconds to activate cleaning while the collector is ON. You can also activate this function by pressing the CLEAN button on the remote for 3 seconds.

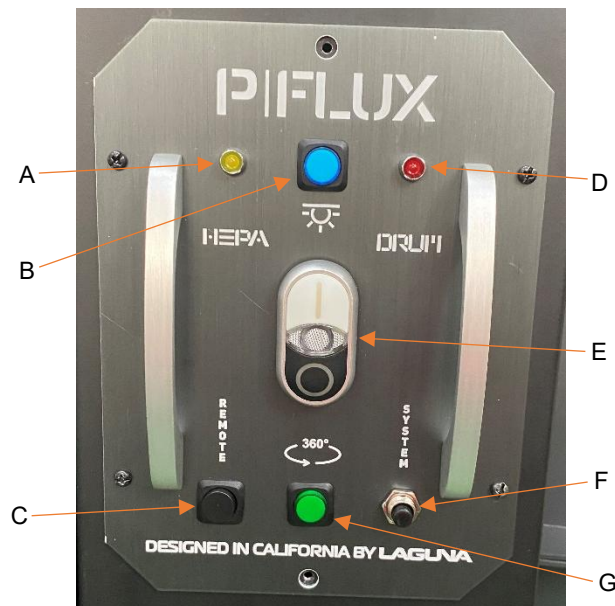

Remote control

The remote control requires a 12V battery type 27A.

- A. ON button
- B. OFF button
- C. CLEAN button (PFlux only)
- D. Remote control pair button



Pairing remote control

1. Ensure the machine is ON before pairing the remote control.
2. Press the control panel pair button until you hear two beeps.
3. Press the remote control pair button simultaneously with the control panel pair button until you hear three beeps. The remote control is now paired.

Pairing more remote controls

You can pair up to 5 remotes to one machine. Each remote must be paired separately. If you pair a sixth remote to the machine, the first paired remote will be disconnected and replaced by the sixth remote. This also applies to the next remotes.

5. Setup

Approximate assembly and setup time: 4-5 hours

5.1 Unpacking

When unpacking, separate the machine and all supplied parts from the packaging materials. Check that no parts have been damaged. If damage has occurred as a result of transport, contact your supplier immediately.

The dust collector is supplied in a single box. Two persons are required to remove the machine from the box! The collector is heavy, be careful when lifting and moving.

1. Carefully cut the banding straps.
2. Cut along the tape line at the top of the box.
3. Remove all parts from the top of the polystyrene and set aside.
4. Remove the polystyrene packing material from the top of the machine.
5. Carefully take out the machine components from the box and set aside.
6. Check all parts according to package contents.

5.2 Assembly

Required tools (not supplied):

- Wrench – 10 mm; 12 mm; 14 mm
- Phillips screwdriver
- Hex key - 4 mm; 5 mm
- Silicone

Step 1: With the help of another person, remove the dust chute from the package.



Step 2: Remove base frame that is bolted to (3x) top upright supports. Keep (6x) 3/8"x3/4" bolts and (6x) 3/8" washers.



Step 3: Prepare (16x) 5/16 "x3/4" bolts and (16x) 5/16" washers. Install two casters with brakes (B) to the part of the base with the drum opening and the other two casters (A) on the opposite side of the base.



Step 4: Turn the base over with it standing on the casters. Mount the (3x) lower upright supports (top of triangles pointing inside) to the base using (6x) 3/8"x3/4" bolts and (6x) 3/8"x7/8" flat washers.
A - mount the support with one triangle on the filter side.
B - mount the support with two triangles on the front side.
C - mount the support with three triangles on the opposite side.

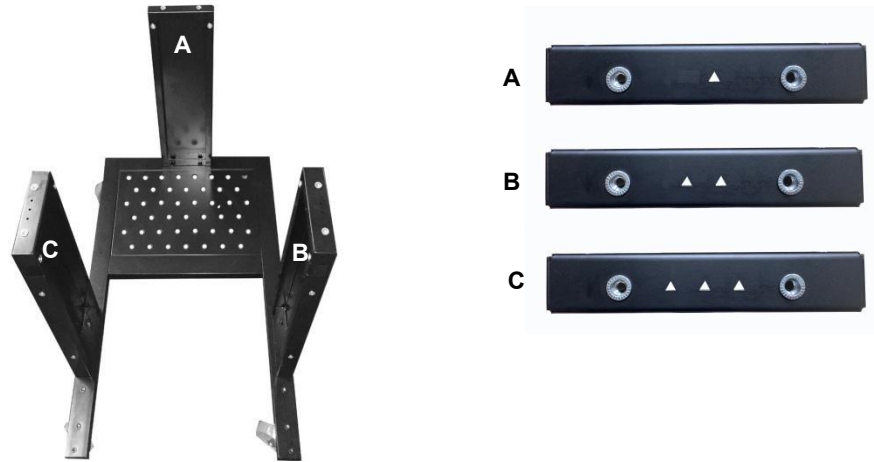

Step 5: With the help of another person, carefully lift the dust chute. Place it on the base with upright supports. Make sure that the lower and top upright supports fit together. Connect the supports using (6x) 5/16 "x3/4" bolts and (6x) 5/16" washers.



Step 6: Secure (3x) upright support reinforcement plates where the top and lower upright supports meet using (12x) 5/16 "x3/4" bolts and (12x) 5/16" washers.

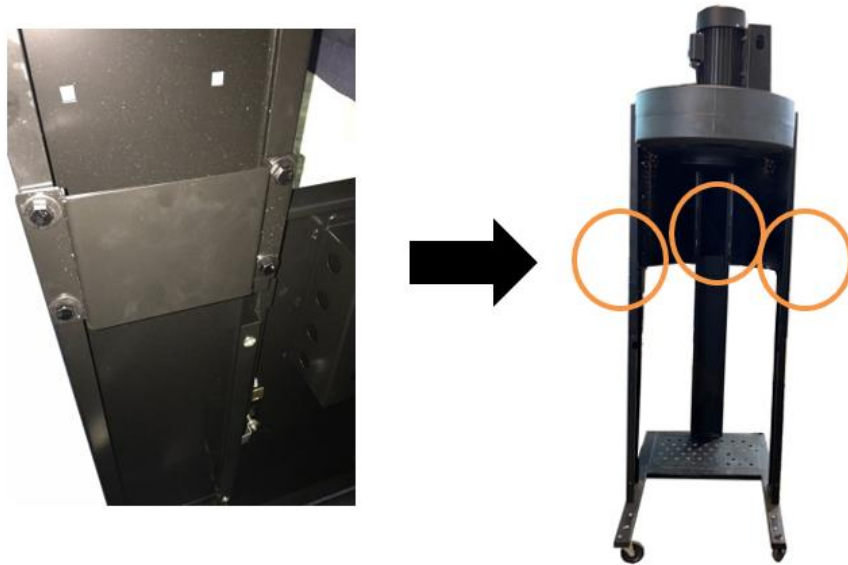

Step 7: Take the junction box and attach it to the base. Use (2x) 1/4"x3/4" bolts and (2x) 1/4" washers.



Step 8: Apply 3x6mm foam tape to the upper and lower rims of the following three components: intake cylinder (top rim), cyclone barrel (top rim), cyclone funnel (top and bottom rim).

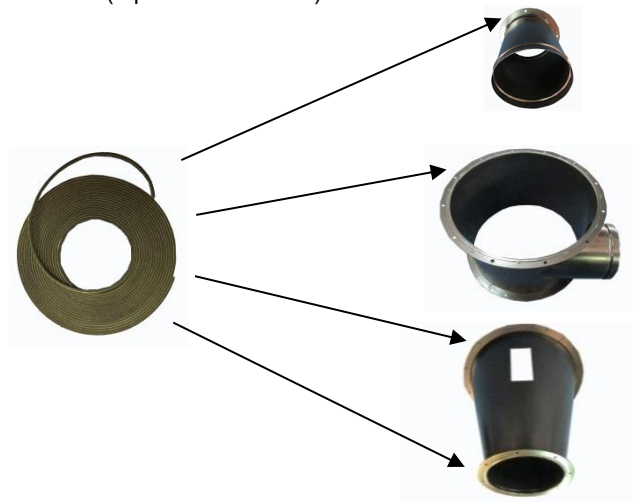

Step 9: Attach the intake cylinder to the dust chute with (4x) 5/16"x5/8" bolts and (4x) 5/16" washers. Then attach the cyclone barrel to the dust chute using (12x) 5/16"x3/4" bolts and (12x) 5/16" washers. Next, attach the cyclone funnel to the dust chute using (12x) 5/16"x3/4" bolts, (24x) 5/16" washers and (12x) 5/16" nuts.



Step 10: Secure the filter cover using (4x) 1/4"x3/4" bolts and (4x) 1/4" washers.

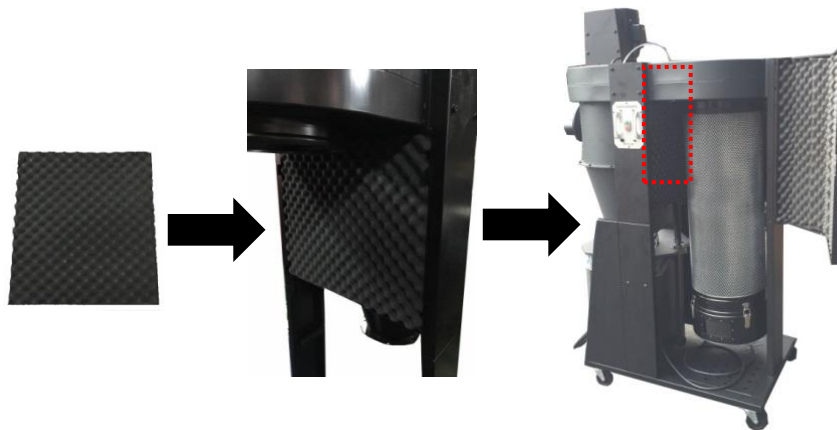

Step 11: Take the Autoclean motor and apply 3x6mm foam tape to the shaft base.

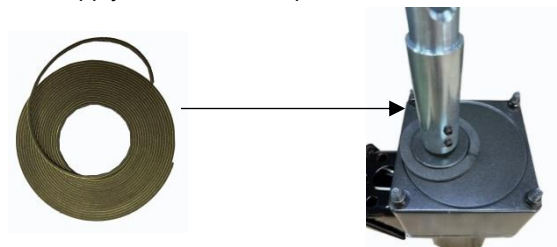

Step 12: Loosen and remove the four bolts, eight washers and four nuts from the motor. Set aside for step 14.



Step 13: Take the Autoclean plate and place it over the Autoclean motor. Make sure the four bolt holes on the Autoclean plate match the holes on the Autoclean motor.

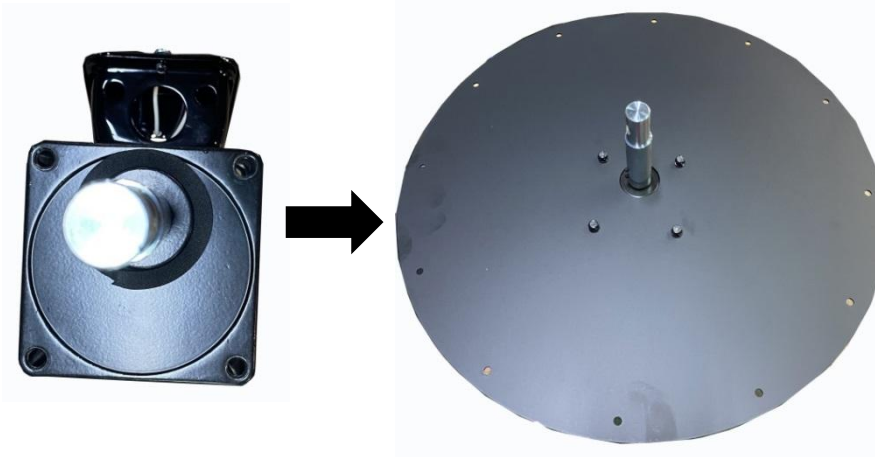

Step 14: Take the hardware removed in step 12 to fasten the Autoclean motor to the plate. Thread the bolts on the Autoclean motor side (A) and the nuts on the plate side (B). Do not fasten the bolts and nuts the other way round.



A



B

Step 15: Apply foam tape to the edge of the plate (between the edge and screw holes). Attach the filter cover to the dust chute using (12x) 3/16"x1/2" sheet metal screws.



Step 16: Attach the (2x) rotation paddles to the rotation shaft using (4x) 1/4"x5/8" screws, (8x) 1/4" washers and (4x) 1/4" nuts.

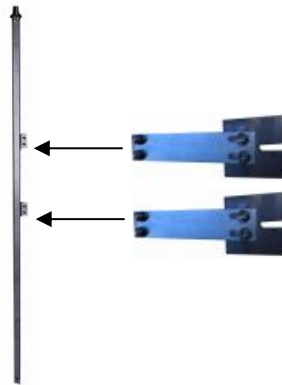

Step 17: Insert the rotation shaft assembly into the HEPA filter. It will be easier to insert while holding it at an angle. Insert the bottom end of the shaft into the hole in the bottom of the filter.

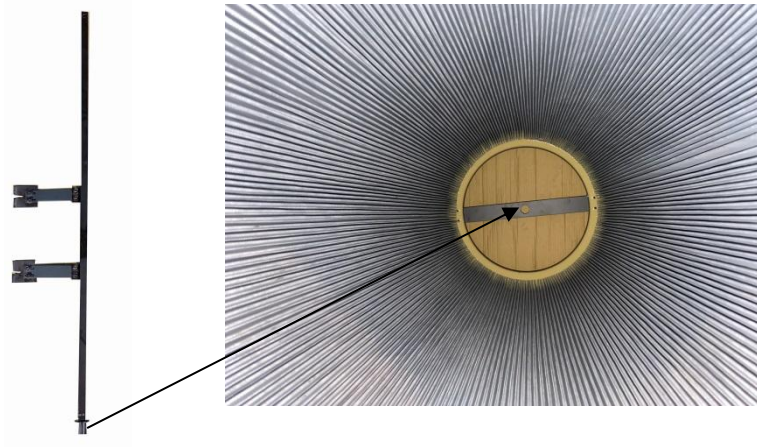

Step 18: Move HEPA filter assembly under the dust chute. With the help of another person holding the HEPA filter, secure the top end of the rotation shaft to the cleaning spindle inside the dust chute using (1x) 5/16"x1-1/2" bolt, (2x) 5/16" washers and (1x) 5/16" lock nut.

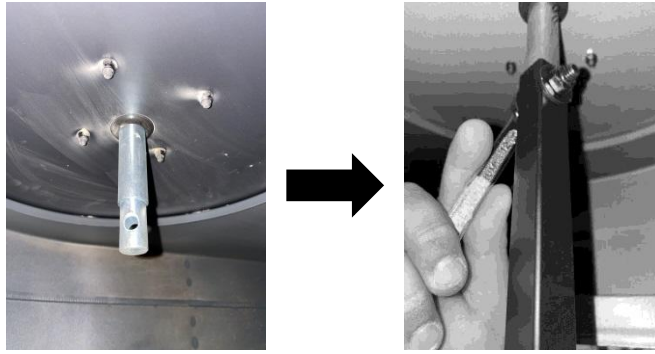

Step 19: Tighten the (1x) 5/16"x3/4" screw and (1x) 5/16" washer on the bottom of the rotation shaft.



Step 20: Open the filter shield and secure the HEPA filter to the dust chute by fastening the band clamp on the top part of the filter. Make sure the band clamp is tightly fastened.



Step 21: Attach the filter end cap to the HEPA filter using the (4x) latches. Cover the opening with a rubber plug.



Step 22: Secure the lower triangular support plate to the base using (2x) 5/16"x3/4" bolts and (2x) 5/16" washers. Follow the same steps for the opposite side.



Step 23: Secure the lifting mechanism support to the lower upright support using (2x) 5/16"x1/2" bolts, (2x) 5/16" washers and (2x) 5/16" nuts.



Step 24: Find the left (A) and right (B) bar for lifting mechanism. To identify the correct side, look for the protruding nut. It should be facing upwards when you place the bars on the floor.

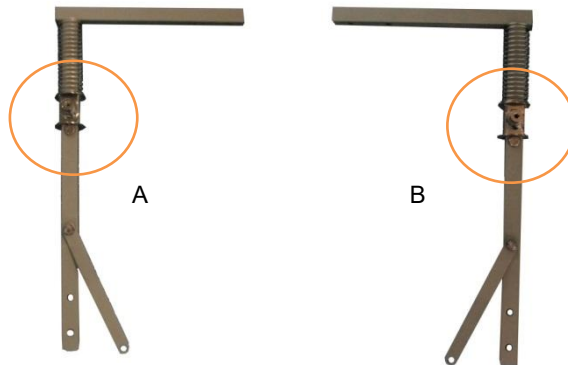

Step 25: Slide the bar into the opening on the lower upright support. Follow the same steps for the opposite side.



Step 26: Make sure the bar is pushed all the way into the opening on the lower upright support. Secure the bar using (4x) 5/16"x1-3/4" bolts, (8x) 5/16" washers and (4x) 5/16" nuts. Follow the same steps for the opposite side.

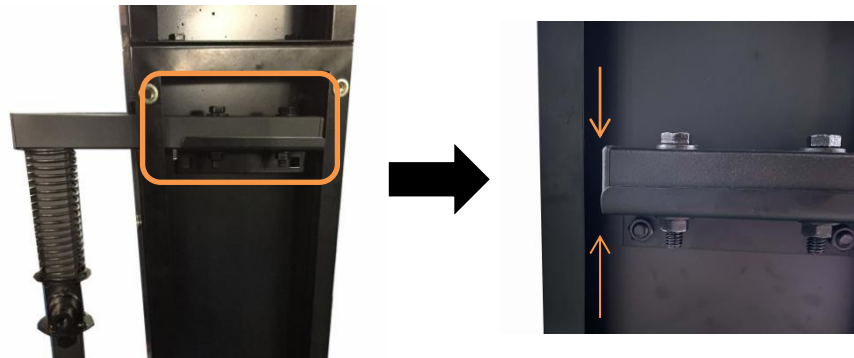

Step 27: Secure the U-channel (A) to the triangular support plate using (2x) 5/16"x1-3/4" bolts, (4x) 5/16" washers and (2x) 5/16" nuts so that the bolt head is on the inside (B). Follow the same steps for the opposite side.

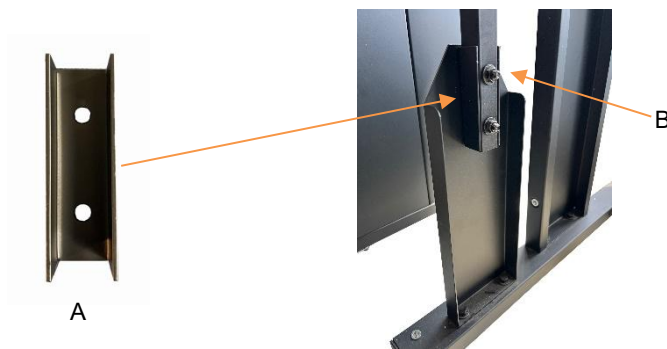

Step 28: Cover the lifting mechanism with lower cover plates. Secure using (6x) 1/4"x3/4" hex bolts and (6x) 1/4" washers. Follow the same steps for the opposite side.

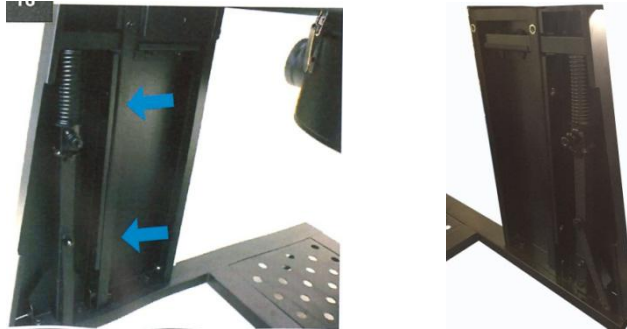

Step 29: Attach both ends of the handle for lifting drum to the nut of the lifting mechanism.

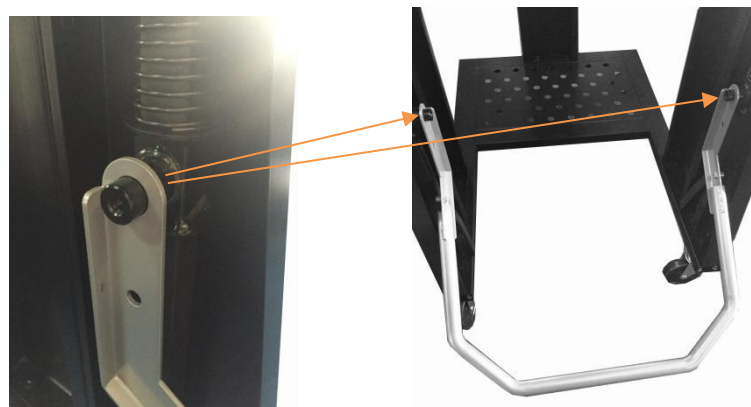

Step 30: Secure with cover. Cover is attached using (1x) M8x30 mm bolt. Follow this step on the opposite side.



Step 31: Secure the bar to the handle using (2x) 3/8"x21mm bolts and 3/8" nuts. Make sure the bolt head is on the inside of the handle (A). Adjust the tightness of this bolt accordingly. If this bolt is too tight, the lifting mechanism will not work smoothly. When too loose it will not pick up the drum.



Step 32: Attach the drum lid to the cyclone funnel with applied foam tape using (6x) 5/16"x3/4" bolts, (12x) 5/16" washers and (6x) 5/16" nuts. On the funnel you will find the following label:

ATTENTION! Do not tighten the (8x) bolts that mount the cyclone funnel to the drum lid. First, perfectly align the drum lid parallel to the upright supports. The drum lid can be swivelled about 30 degrees +/- . Failure to do so will make the drum poorly sealed and unable to fit between supports. Remove this label after completing this step.



○

ATTENTION

Do not tighten the 8 X bolts that mounts to cone flange to top of drum lid until you have perfectly aligned the drum lid up parallel to the uprights.

This ingenious design allows you to swivel the drum lid about 30 degrees +/-

Failure to do so will make the drum unable to fit in space between vertical uprights.

Step 33: Attach the full drum detection sensor to the opening on the drum lid located behind the cyclone funnel. When securing the sensor make sure the end of the sensor (A) is not longer than the drum lid rim (B). If it extends past the rim, the detection will not function correctly.



Step 34: Attach the LED light to the drum lid using (6x) M4*10mm bolts, (6x) 3/16" washers and (6x) M4 nuts.



Step 35: Attach the crossbar to the drum lid and tighten using (2x) 5/16"x3/4" bolts, (4x) 5/16" washers and (2x) 5/16" nuts. It does not matter which position you attach the crossbar.

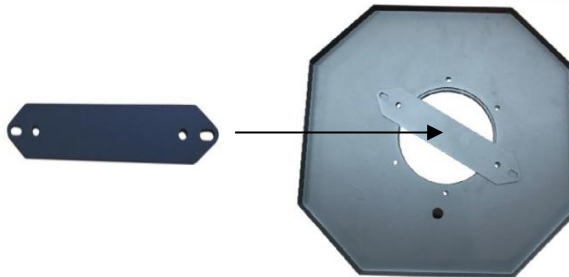

Step 36: Assemble the drum. Find the drum base panel and secure the (4x) casters using (16x) 5/16"x3/4" bolts, (32x) 5/16" washers and (16x) 5/16" nuts.

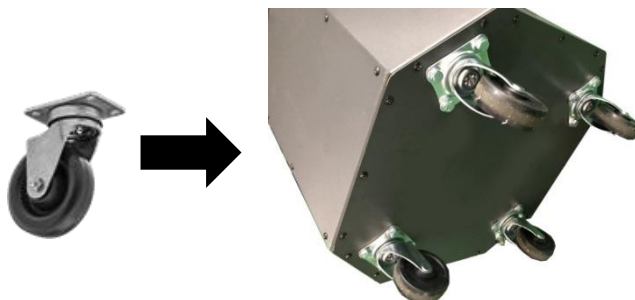

Step 37: Attach the handles to the top and bottom end on the front drum panel using (4x) 5/16"x3/4" bolts, (4x) 5/16" washers and (4x) 5/16" nuts. Note that the head of the bolt must be inserted from the handle with the nut and washer on the inside of the drum.



Step 38: Assemble front and back drum panel using (12x) M4x12mm sheet metal screws.

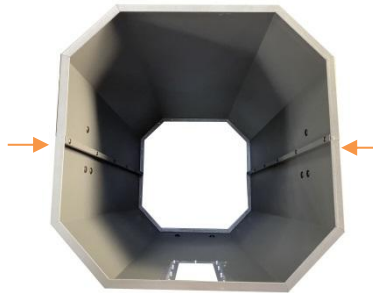

Step 39: On the left and right side of the drum you will find three bolt holes. Secure the matching side plate to the drum panel using (6x) 1/4"x1/2" bolts, (6x) 1/4" washers and (6x) 1/4" nuts. Insert the head of the bolt from the inside of the drum with the washers and nuts on the outside of the drum.

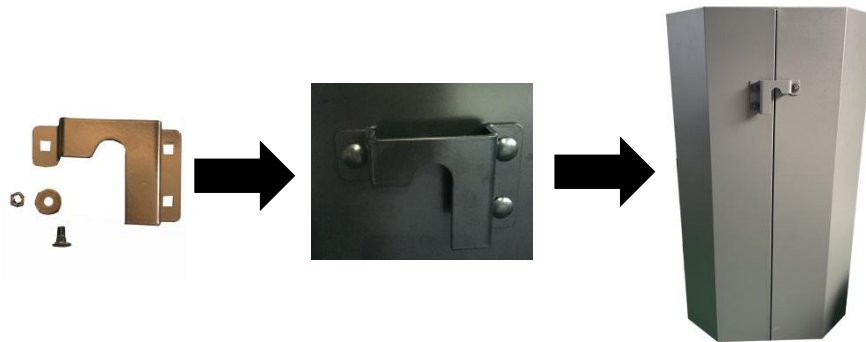

Step 40: Lay the drum on its side. With the help of another person, align the drum with the base with attached casters. Using (22x) M4 sheet metal screws fasten tightly.



Step 41: (22x) Cover all (22x) screws with (22x) plastic caps.



Step 42: Once assembly is complete, apply silicone (not included) to the top and bottom rim inside the drum. This will seal the drum and prevent any leaks.

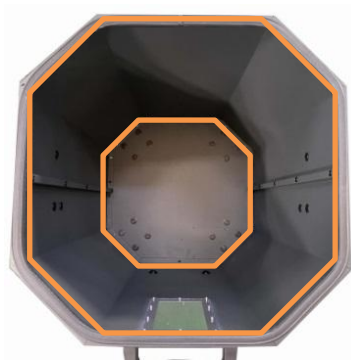

Step 43: Attach the rubber gasket to the top rim of the drum. Remove excess rubber gasket.

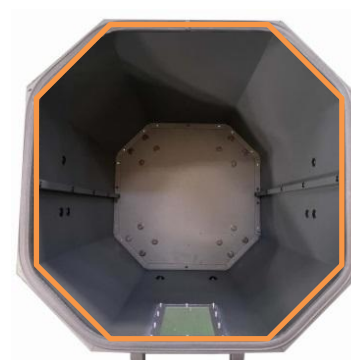

Step 44: Insert waste bag in the drum. Spread the bag all over the drum.



Step 45: Use (24x) 3/16"x1/2" bolts and (24x) 3/16" nuts to assemble the drum insert. Place the drum insert inside over the plastic bag.



Step 46: Lift the bar. Push the drum in and align. Lower the bar to seal the drum tight for normal machine operation.



Step 47: Make sure when aligning the drum that both the left and right side plates are seated in the lifting mechanism (A). When aligned incorrectly (B), the drum will not be fully sealed and will interfere with the airflow.



A



B

Step 48: With the white plastic pin, you can adjust the detection rate of a full drum. Insert the tip of the pin into the top end of the sensor.

Turn clockwise to lower the full detection rate (less waste in the drum).

Turn counterclockwise to increase the full detection rate (more waste in the drum).



Step 49: Install the inlet adaptor with 3 openings using (3x) M4x12mm sheet metal screws. Attach the rubber caps to each opening. Assembly is now completed.



5.3 Operation

1. Remove the rubber cap from the connected opening. Check all parts of a dust collection system to ensure sufficient airflow.

Warning! Do not turn the collector on when all blast gates are closed!

2. Confirm that the power supply is connected correctly and without damage.

3. Check the surroundings. Do not carry out any repairs or maintenance on the machine when in use!

4. To start, press the ON button on either the control panel or paired remote control.

5. To stop, press the OFF button on either the control panel or paired remote control

6. Maintenance and Inspection

Caution! Disconnect the machine from the power supply before maintenance and inspection. Carry out maintenance regularly.

Before each use, check for loose or damaged parts and whether the cord is worn out or damaged. Do not use the machine until all defects have been fixed. **After each use**, clean dust and other waste from the machine and surrounding area. Wipe the machine using a dry cloth.

Carry out the following tasks regularly:

- Check for leaks.
- Clean the filter and its parts.

6.1 Emptying the Drum

Periodically inspect the contents of the drum and empty as needed. To inspect the contents of the drum, check the full drum detection, look through the window or remove the drum.

1. Raise the handle for lifting drum to lower the drum on the floor.

2. Slide the drum out of the machine, check and empty as needed.

6.2 Emptying the Filter End Cap

Periodically inspect the filter end cap. If it is more than one third full, empty it. If the filter end cap gets too full, dust can be pulled back into the filter. This restricts airflow and can expose you to harmful particles.

1. Release the (4x) latches around the filter end cap and remove it.
2. Empty the cap and reattach using latches.

6.3 Cleaning the HEPA Filter

The HEPA filter automatically cleans every 10 minutes for 10 seconds clockwise and 10 seconds counterclockwise. Automatic cleaning also starts whenever you turn the machine off. While the filter is being cleaned, the yellow LED light for HEPA filter detection illuminates on the control panel.

The yellow LED light for HEPA filter detection can also flash in one long and two short intervals if the HEPA filter needs to be replaced.

For heavy duty users, it is recommended to use compressed air regularly to maintain maximum filtration efficiency and longer service life.

1. Empty the filter end cap.
2. Open both filter shields. Connect an extraction hose from the inlet adaptor to the filter end cap.
3. Turn the machine on and leave it running.
4. Use compressed air to blow the filter from the outside.
5. Turn the machine off and empty the filter end cap.

6.4 Replacing the HEPA Filter

To maintain good air quality in your workshop and to ensure proper filtration, the HEPA filter should be replaced after approximately 2000 hours of operation (8 hours/day x 250 days = 2000 hours). Please contact your supplier for HEPA filter replacement.

To replace the HEPA filter, follow the steps below. Disconnect the machine from the power supply!



1. Release the (4x) latches around the filter end cap and set it aside.
2. Remove the rotation shaft bolt from the bottom of the shaft using a 12 mm wrench. Remove (4x) bolts connecting the bottom part to the filter.
3. Slide the shaft out and set all components aside.
4. Open filter shields and release the band clamp at the top of the filter. Support the filter from the bottom.
5. Remove and replace the HEPA filter. To install a new HEPA filter, repeat the steps above in reverse.
6. After replacing HEPA filter, press the remote control pair button five times. The LED indicator is now reset to zero.

7. Accessories

Recommended accessories is listed on the IGM website.

Caution! Installing unapproved accessories may cause damage to the machine and serious injury. Use only accessories recommended for this machine by IGM.

8. Troubleshooting

<p>Machine does not start or a breaker trips. Possible Cause:</p> <ol style="list-style-type: none"> 1) Power supply is turned OFF or faulty. 2) Wall fuse/circuit breaker is blown/tripped. 3) Faulty remote control. 4) Remote receiver is faulty. 5) Incorrectly wired motor connection. 6) On-board circuit breaker is tripped. 7) Wiring is open/has high resistance. 8) Faulty power switch. 9) Faulty switch. Motor is at fault. 	<p>Possible Solution:</p> <ol style="list-style-type: none"> 1) Ensure power supply is ON and has the correct voltage. 2) Ensure adequate circuit size, reset breaker. 3) Replace batteries; ensure unobstructed line of sight and signal range. 4) Inspect receiver circuit board; replace if faulty. 5) Rewire or call certified service technician or electrician. 6) Allow motor to cool, improve ventilation, press reset button. 7) Check for broken wires or poor connections, repair as necessary. 8) Replace switch. 9) Test/repair/replace.
<p>Excessive vibration or noise during operation. Possible Cause:</p> <ol style="list-style-type: none"> 1) Loose component. 2) Loose or broken motor mount. 3) Motor fan hitting fan cover. 4) Bad motor bearings. 	<p>Possible Solution:</p> <ol style="list-style-type: none"> 1) Inspect and tighten all bolts/nuts. 2) Tighten or replace as needed. 3) Check fan and cover; replace as needed. 4) Rotate shaft manually, check for grinding or loose shaft, replace bearings if needed.
<p>Loud or repetitive noise, excessive vibration coming from machine. Possible Cause:</p> <ol style="list-style-type: none"> 1) Machine is on uneven surface. 2) Damaged/Unbalanced fan. 3) Loose connections. 4) Fan is loose. 5) Motor fan hitting fan cover. 	<p>Possible Solution:</p> <ol style="list-style-type: none"> 1) Stabilize on a flat surface. 2) Inspect fan for dents, bends, or other damage. 3) Check and re-tighten all fasteners. 4) Replace the motor and fan. 5) Check fan and cover; replace as needed.

<p>Cyclone collector does not adequately collect dust or chips; poor performance. Possible Cause:</p> <ol style="list-style-type: none"> 1) Drum or filter end cap are full. Filter is dirty. 2) Clogged dust collection. 3) Dust collection is too long or has too many sharp bends. 4) Wet lumber is clogging collection. 5) Leaks in the dust collection or too many open blast gates. 6) Inadequate velocity in the main collection line. 7) Wrong size ducting/ports used. 	<p>Possible Solution:</p> <ol style="list-style-type: none"> 1) Empty drum and filter end cap. Clean filter. 2) Clean inlet adaptor. 3) Move the machine closer to the point of collection. Rerun ducts to eliminate sharp bends. 4) Use lumber with less than 20 % moisture content. 5) Repair all leaks and close any gates not being used. 6) Increase velocity by opening 1 or 2 more blast gates to different branch lines. 7) Re-size and re-install ducts and fittings.
<p>Sawdust being blown into the air from the cyclone collector. Possible Cause:</p> <ol style="list-style-type: none"> 1) Band clamps are not secure. 2) Loose or damaged seals. 	<p>Possible Solution:</p> <ol style="list-style-type: none"> 1) Re-install ensuring a tight fit. 2) Replace seals and gaskets.

9. Wiring

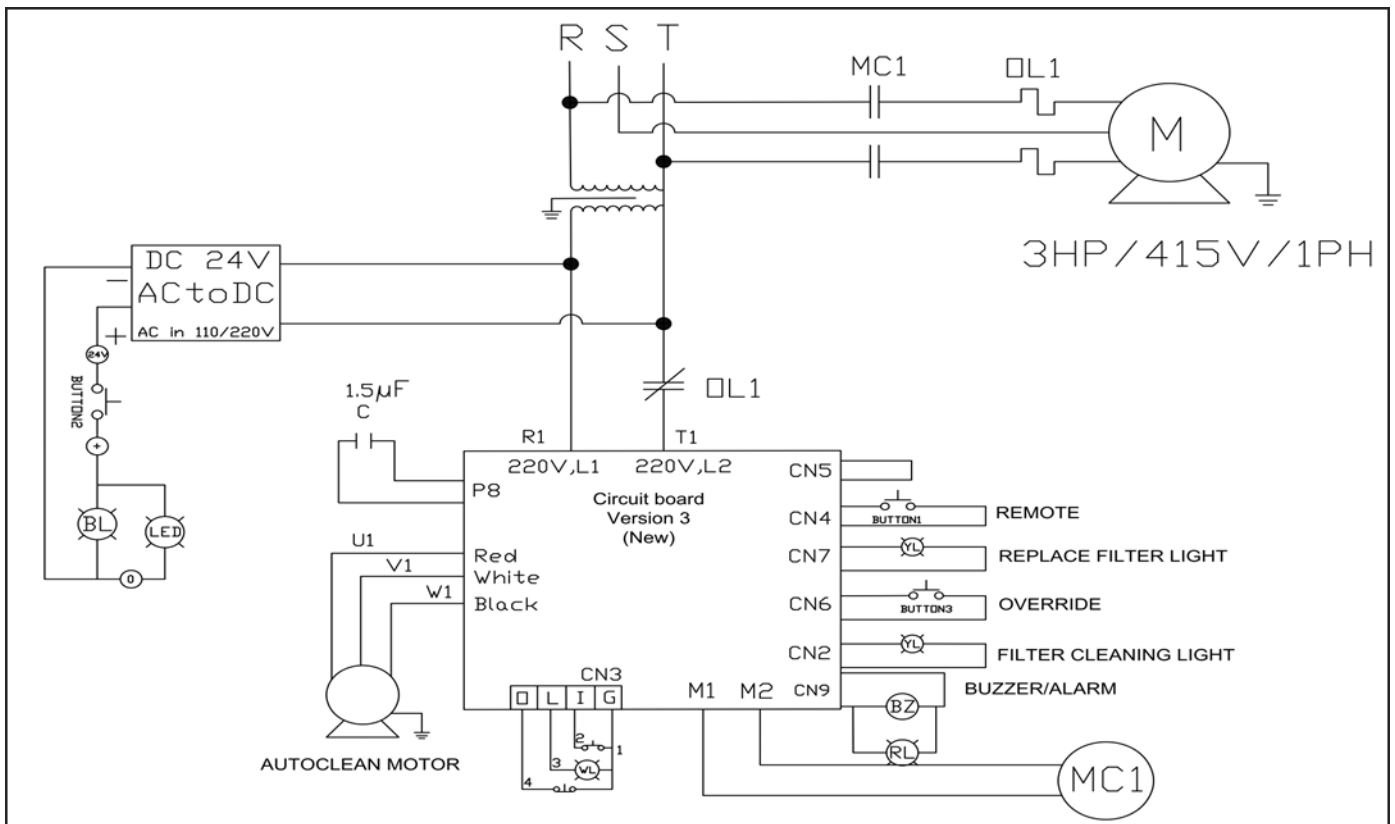

Control panel

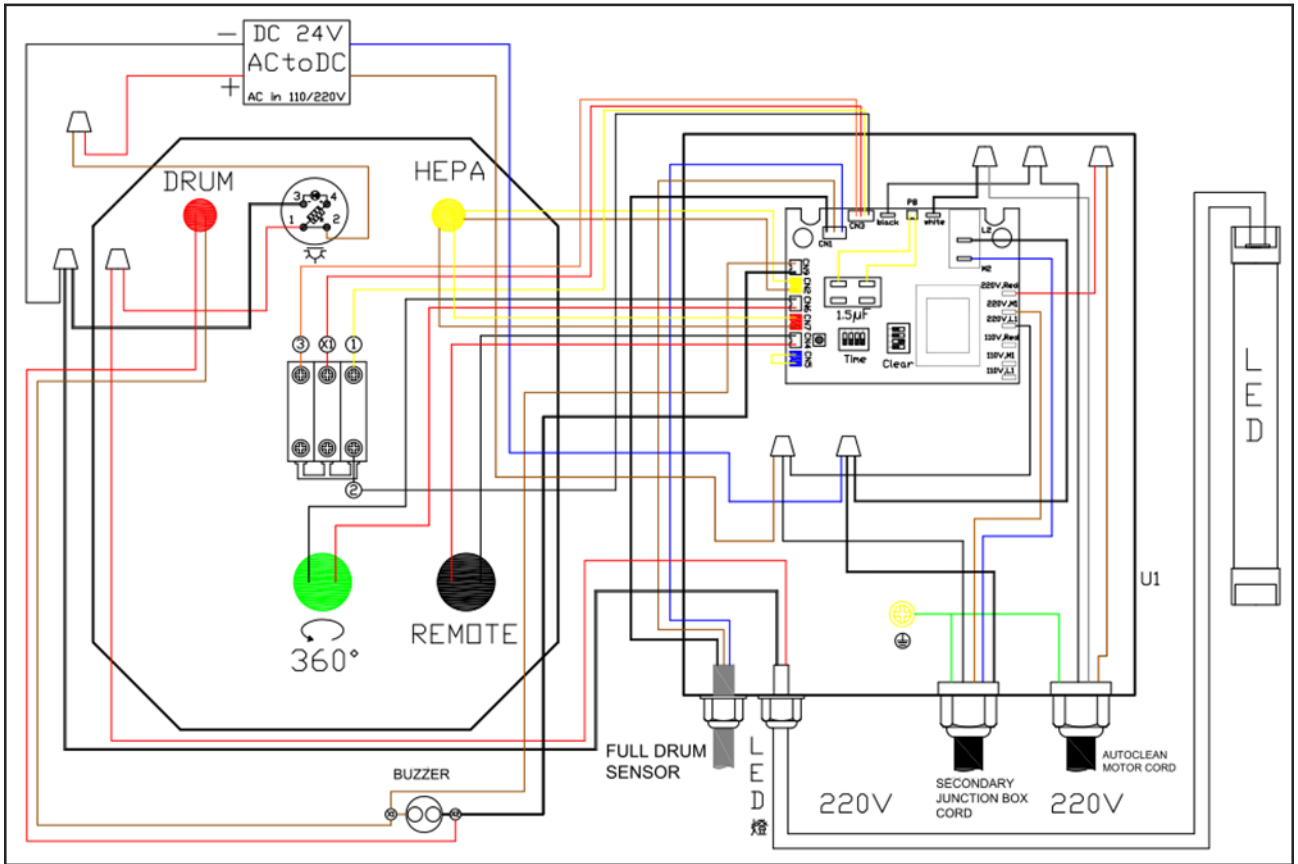

Secondary control box

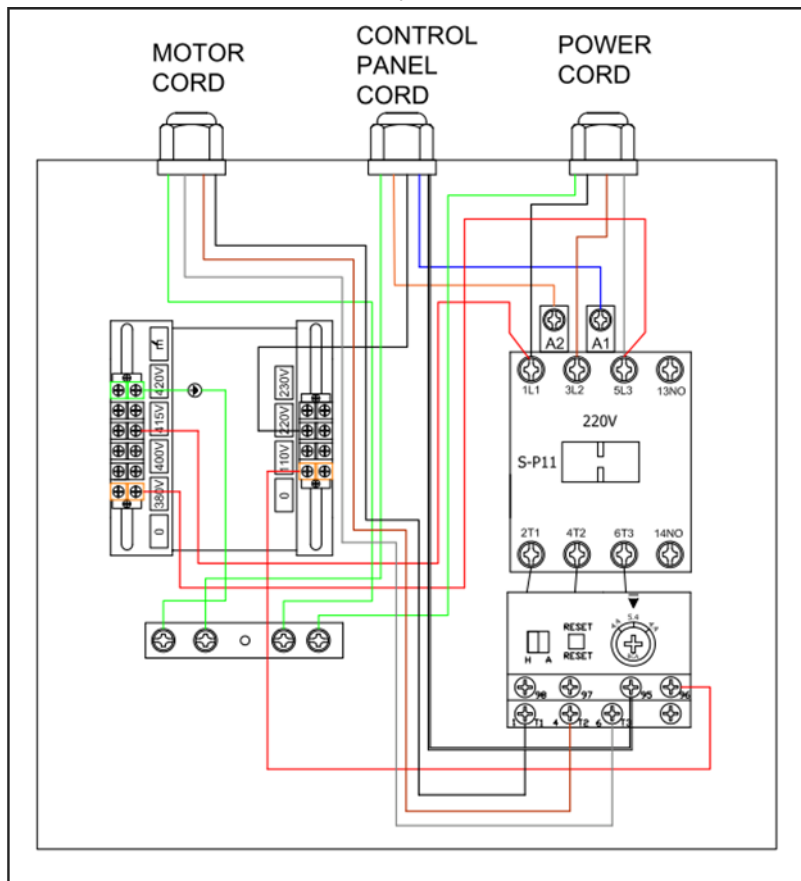

Autoclean motor

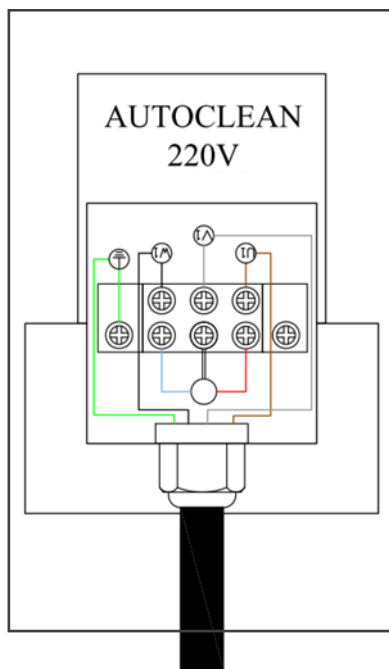

10. Parts List

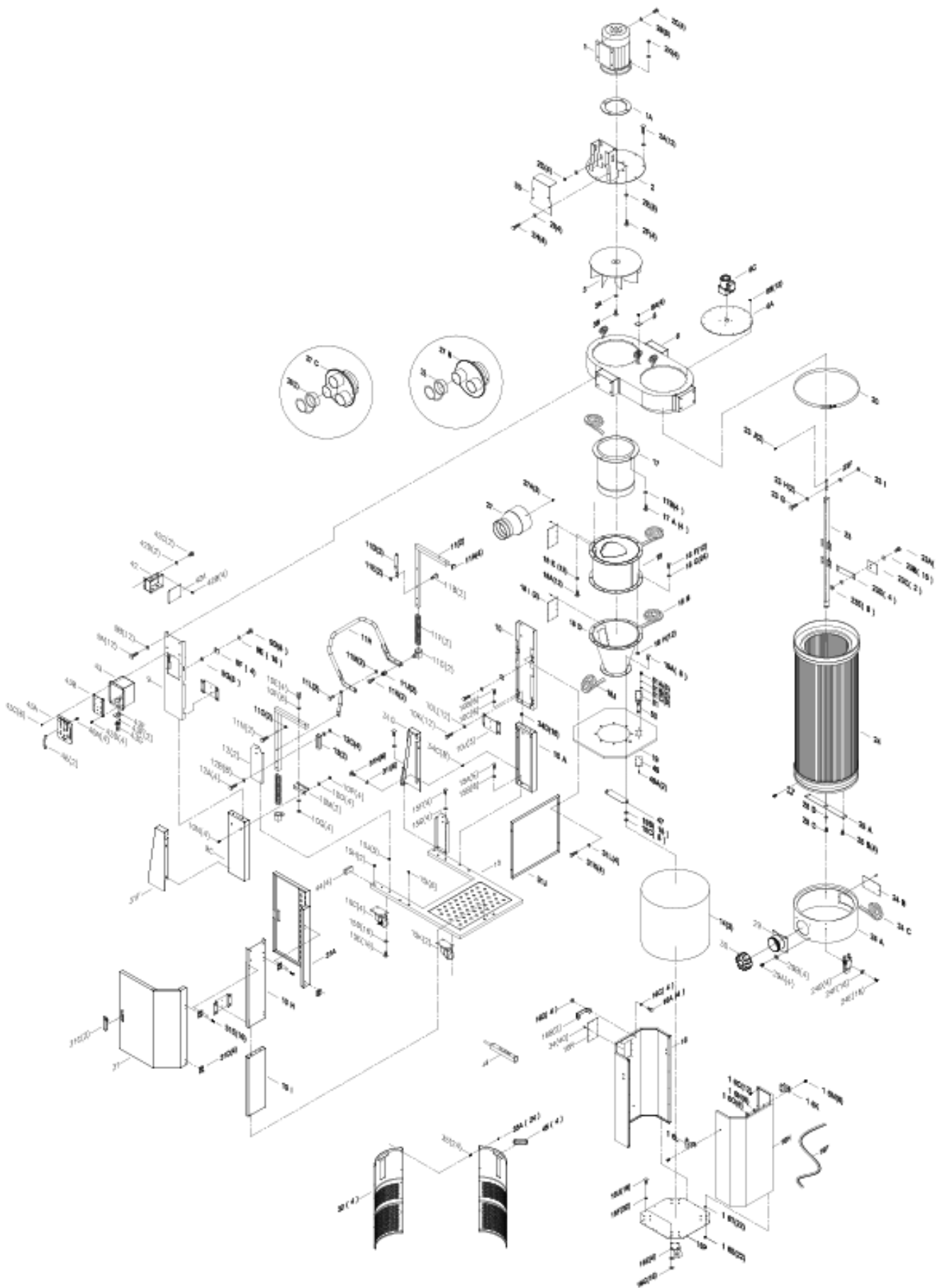

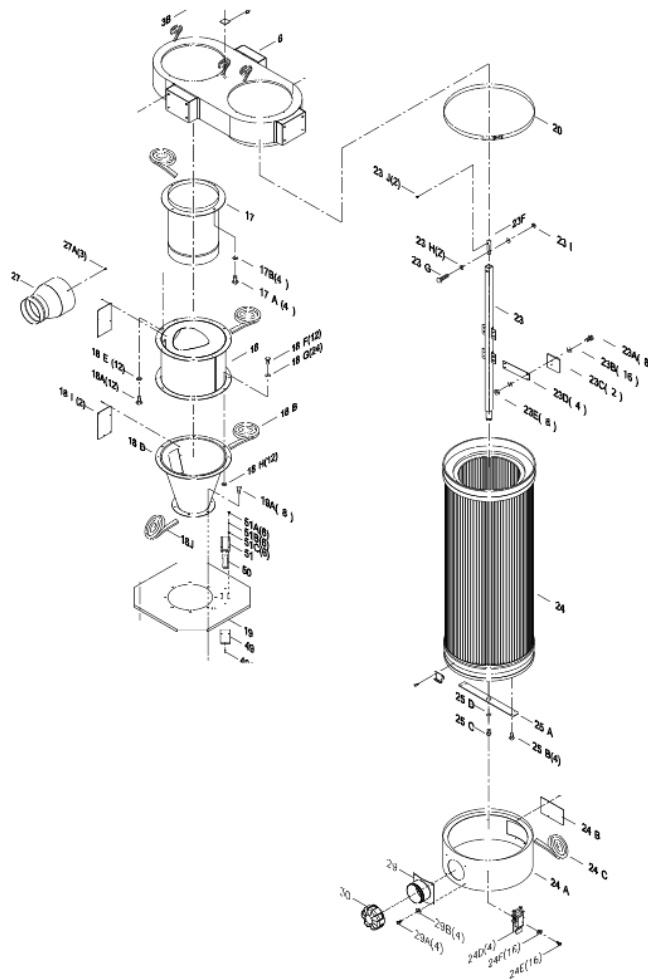
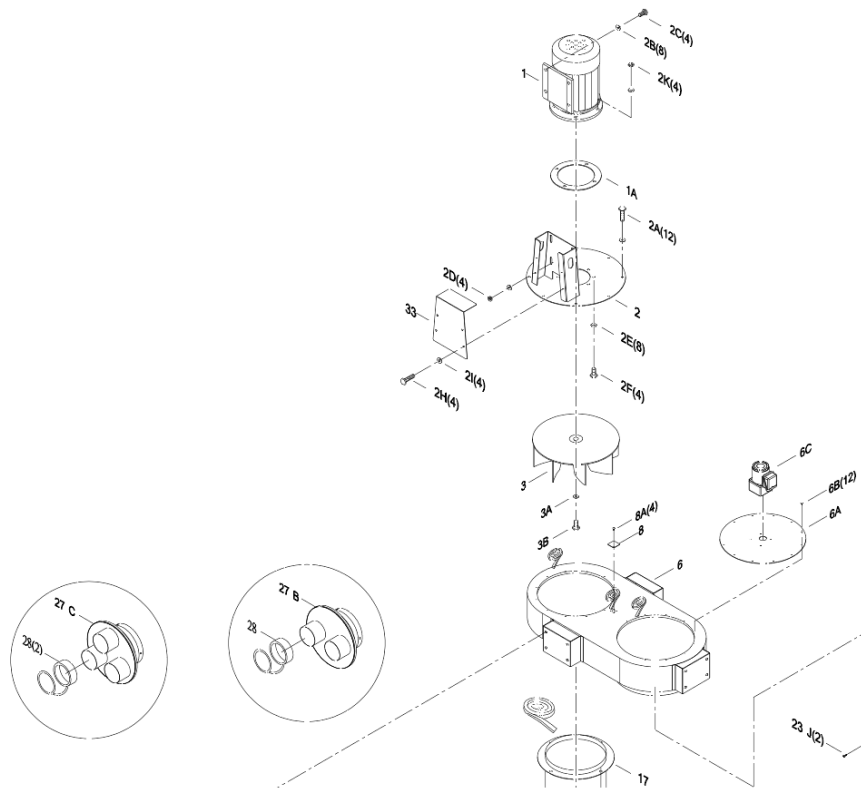

No	OBPart Name	Description	Q'TY	No	Part Name	Description	Q'TY
1	PDCPF22201-1	MOTOR 2HP	1	9C	PDCPF22201-9CV2	LOWER UPRIGHT SUPPORT TWO DOT (3B) V2.2021	1
1	PDCPF32201-1	MOTOR 3HP	1	9D	PDCPF22201-9D	HEX BOLT 1/4"x5/8"	8
1A	PDCPF22201-1A	MOTOR GASKET	1	9E	PDCPF22201-9E	FLAT WASHER 1/4"xOD13x1t	16
2	PDCPF22201-2	MOTOR SUPPORT BASE	1	9F	PDCPF22201-9F	DOOR STOP PLATE	4
2A	PDCPF22201-2A	HEX LOCK BOLT 5/16" x 5/8"	12	9G	PDCPF22201-9G	HEX NUT 1/4"	8
2B	PDCPF22201-2B	FLAT WASHER 3/8"xOD23x2t"	8	10	PDCPF22201-10V2	TOP UPRIGHT SUPPORT A V2.2021	1
2C	PDCPF22201-2C	HEX BOLT 3/8" x 1"	4	10A	PDCPF22201-10AV2	LOWER UPRIGHT SUPPORT THREE DOT V2.2021	1
2D	PDCPF22201-2D	HEX NUT 3/8"	4	10B	PDCPF22201-10B	HEX BOLT 5/16" x 3/4"	6
2E	PDCPF22201-2E	FLAT WASHER 3/8"xOD23x2t	8	10C	PDCPF22201-10C	FLAT WASHER 5/16"xOD18x2t	6
2F	PDCPF22201-2F	HEX BOLT 3/8" x 1-1/4"	4	10E	PDCPF22201-10E	HEX BOLT 5/16" x 1-3/4"	4
2H	PDCPF22201-2H	HEX BOLT 1/4" x 3/4"	4	10F	PDCPF22201-10F	FLAT WASHER 5/16"xOD18x2t	8
2I	PDCPF22201-2I	FLAT WASHER 1/4"xOD19x1t	4	10G	PDCPF22201-10G	HEX NUT 5/16"	4
2K	PDCPF22201-2K	HEX LOCK NUT 3/8"	4	10H	PDCPF22201-10H	TOP UPRIGHT SUPPORT ONE DOT (1A)	1
3	PDCPF22201-3	FAN 14.5" (PFLUX2 ONLY)	1	10I	PDCPF22201-10IV2	LOWER UPRIGHT SUPPORT ONE DOT V2.2021	1
3	PDCPF32201-3	FFAN 15.5" (PFLUX3 ONLY)	1	10J	PDCPF22201-10J	UPRIGHT SUPPORT REINFORCEMENT PLATE	3
3A	PDCPF22201-3A	FLAT WASHER 3/8"xOD45x3t	1	10K	PDCPF22201-10K	HEX BOLT 5/16" x 3/4"	12
3B	PDCPF22201-3B	HEX BOLT 3/8"x1"	1	10L	PDCPF22201-10L	FLAT WASHER 5/16"xOD18x2t	12
6	PDCPF22201-6	DUST CHUTE	1	10M	PDCPF22201-10M	FOOT PEDDLE BAR SUPPORT	2
6A	PDCPF22201-6A	CANISTER COVER PLATE	1	10N	PDCPF22201-10N	CARRIAGE BOLT 5/16"x1/2"	4
6B	PDCPF22201-6B	SHEET METAL THREAD BOLT 3/16" x 1/2"	12	10O	PDCPF22201-10O	FLAT WASHER 5/16"xOD18x2t	4
6C	PDCPF22201-6C	AUTO CLEAN MOTOR	1	10P	PDCPF22201-10P	HEX NUT 5/16"	4
8	PDCPF22201-8	COVER PLATE	1	11	PDCPF22201-11	FOOT PEDDLE BAR	2
8A	PDCPF22201-8A	SHEET METAL THREAD BOLT M4x12mm	4	11A	PDCPF22201-11A	PLUG 25, 25	4
9	PDCPF22201-9V2	TOP UPRIGHT SUPPORT B V2.2021	1	11B	PDCPF22201-11B	HEX BOLT 3/8"	2
9A	PDCPF22201-9A	HEX BOLT 5/16" x 3/4"	12	11D	PDCPF22201-11D	MOVEABLE SUPPORT BRACE	2
9B	PDCPF22201-9B	FLAT WASHER 5/16"xOD18x2t	12	11E	PDCPF22201-11E	HEX LOCK NUT 3/8"	2
11F	PDCPF22201-11F	SPRING Ø42mm x 242mm L	2	15K	PDCPF22201-15K	SWIVEL CASTER	2
11G	PDCPF22201-11G	SKID BLOCK	2	16	PDCPF22201-16V2	OCTAGON DRUM FRONT PANEL V2.2021	1
11H	PDCPF22201-11H	OCTAGON DRUM FOOT PEDDLE	1	16A	PDCPF22201-16A	FLAT HEAD PHILIP BOLT 5/16"x3/4"	4
11J	PDCPF22201-11J	TOPPING Ø24mm*30mm	2	16B	PDCPF22201-16B	HANDLE	2
11K	PDCPF22201-11K	HEX BOLT M8*30mm	2	16C	PDCPF22201-16C	FLAT WASHER 5/16"xOD23x2t	4
11L	PDCPF22201-11L	HEX BOLT 3/8"	2	16D	PDCPF22201-16D	HEX NUT 5/16"	4
11M	PDCPF22201-11M	HEX LOCK NUT 3/8"	2	16E	PDCPF22201-16E	DRUM CASTER 3"	4
11N	PDCPF22201-11N	HEX BOLT 3/8" x 1-1/2"	2	16U	PDCPF22201-16U	HEX BOLT 5/16" x 3/4"	16
11O	PDCPF22201-11O	HEX LOCK NUT 3/8"	2	16F	PDCPF22201-16F	FLAT WASHER 5/16"xOD18x2t	32

No	Part Name	Description	Q'TY	No	Part Name	Description	Q'TY
12	PDCPF22201-12V2	TRIANGULAR SUPPORT PLATE V2.2021	2	16G	PDCPF22201-16G	HEX NUT 5/16"	16
12A	PDCPF22201-12A	HEX BOLT 5/16" x 1-3/4"	4	16H	PDCPF22201-16HV2	OCTAGON DRUM BACK PANEL V2.2021	1
12B	PDCPF22201-12B	FLAT WASHER 5/16"xOD18x2t	8	16K	PDCPF22201-16K	LEFT SIDE PLATE	1
12C	PDCPF22201-12C	HEX NUT 5/16"	4	16L	PDCPF22201-16L	RIGHT SIDE PLATE	1
13	PDCPF22201-13	LOWER SUPPORT PLATE	2	16M	PDCPF22201-16M	CARRIAGE BOLT 1/4" x 1/2"	6
14	PDCPF22201-14V2	PLASTIC BAG Ø610 x 1200mm	3	16N	PDCPF22201-16N	FLAT WASHER 1/4"xOD19x2t	6
15	PDCPF22201-15	BASE	1	16O	PDCPF22201-16O	HEX NUT 1/4"	6
15A	PDCPF22201-15A	HEX BOLT 3/8" x 3/4"	6	16P	PDCPF22201-16PV2	OCTAGON DRUM BASE PANEL V2.2021	1
15B	PDCPF22201-15B	FLAT WASHER 3/8" x OD23 x 2t	6	16R	PDCPF22201-16RV2	WINDOW V2.2021	1
15C	PDCPF22201-15C	SWIVEL CASTER 4" W/BRAKES	2	16S	PDCPF22201-16SV2	M4 SHEET METAL SCREW	22
15D	PDCPF22201-15D	FLAT WASHER 5/16"xOD18x2t	16	16T	PDCPF22201-16TV2	PLASTIC BOLT END CAP	22
15E	PDCPF22201-15E	HEX BOLT 5/16" x 3/4"	16	16Q	PDCPF22201-16Q	THREAD BOLT M4 x 12mm	12
15F	PDCPF22201-15F	HEX BOLT 5/16" x 3/4"	4	17	PDCPF22201-17	INTAKE CYLINDER	1
15G	PDCPF22201-15G	FLAT WASHER 5/16"xOD18x2t	4	17A	PDCPF22201-17A	HEX BOLT 5/16" x 5/8"	4
15H	PDCPF22201-15H	RIVET NUT 1/4"	2	17B	PDCPF22201-17B	FLAT WASHER 5/16"xOD18x2t	4
15I	PDCPF22201-15I	RIVET NUT 3/8"	6	18	PDCPF22201-18	CYCLONE BARREL	1
15J	PDCPF22201-15J	RIVET NUT 5/16"	5	18A	PDCPF22201-18A	HEX BOLT 5/16" x 3/4"	12
18B	PDCPF22201-18B	FOAM TAPE 3 x 6mm x 10M	1	24B	PDCPF22201-24B	WINDOW	1
18D	PDCPF22201-18DV2	CYCLONE FUNNEL V2.2021	1	24C	PDCPF22201-24C	FOAM TAPE 5*20mm*1.5M	1
18E	PDCPF22201-18E	FLAT WASHER 5/16"xOD18x2t	12	24D	PDCPF22201-24D	LATCH #98	4
18F	PDCPF22201-18F	HEX BOLT 5/16" x 3/4"	12	24E	PDCPF22201-24E	SHEET METAL BOLT 3/16"*3/8"	16
18G	PDCPF22201-18G	FLAT WASHER 5/16"xOD18x2t	24	24F	PDCPF22201-24F	HEX NUT 3/16"	16
18H	PDCPF22201-18H	HEX NUT 5/16"	12	25A	PDCPF22201-25A	ROTATION SHAFT BASE	1
18I	PDCPF22201-18I	WINDOW	2	25B	PDCPF22201-25B	SHEET METAL PHILIP BOLT 3/16" x 3/4"	4
18J	PDCPF22201-18J	FOAM TAPE 3*15mm*80CM	1	25C	PDCPF22201-25C	HEX BOLT 5/16" x 3/4"	1
19	PDCPF22201-19V2	OCTAGON DRUM LID V2.2021	1	25D	PDCPF22201-25D	FLAT WASHER 5/16" x OD23 x 2t	1
19A	PDCPF22201-19A	HEX BOLT 5/16" x 3/4"	8	27	PDCPF22201-27	REDUCER 8" BY 6"	1
19B	PDCPF22201-19B	FLAT WASHER 5/16"xOD18x2t	16	27A	PDCPF22201-27A	SHEET METAL BOLT M4 * 12mm	3
19C	PDCPF22201-19C	HEX NUT 5/16"	8	27B	PDCPF22201-27B	INTAKE SPLITTER 8" BY 4" X 2 PORT	1
19F	PDCPF22201-19F	RUBBER GASKET 1650mm	1	27C	PDCPF22201-27C	INTAKE SPLITTER 8" BY 4" X 3 PORTS	1
20	PDCPF22201-20	BAND CLAMP Ø400mm	1	28	PDCPF22201-28	RUBBER CAP 4"	1
23	PDCPF22201-23V2	ROTATION SHAFT V2.2021	1	29	PDCPF22201-29	PLASTIC BASE CONNETOR	1
23A	PDCPF22201-23A	HEX BOLT 1/4" x 5/8"	8	29A	PDCPF22201-29A	PH HD BOLT 3/16" x 3/8"	4
23B	PDCPF22201-23B	FLAT WASHER 1/4" x OD13 x 1t	16	29B	PDCPF22201-29B	HEX NUT 3/16"	4
23C	PDCPF22201-23C	PADDLE	2	30	PDCPF22201-30	PLASTIC CAP 4" FOR END CAP	1
23D	PDCPF22201-23D	PADDLE BRANCH	4	31	PDCPF22201-31	CANISTER FILTER SHIELD DOOR-1	1

No	Part Name	Description	Q'TY	No	Part Name	Description	Q'TY
23E	PDCPF22201-23E	HEX LOCK NUT 1/4"	8	31A	PDCPF22201-31A	CANISTER FILTER SHIELD DOOR-2	1
23F	PDCPF22201-23F	ROTATION SHAFT CONNECTION	1	31C	PDCPF22201-31C	DOOR HANDLE	2
23G	PDCPF22201-23G	HEX BOLT 5/16" x 1-1/2"	1	31D	PDCPF22201-31D	HINGE	4
23H	PDCPF22201-23H	FLAT WASHER 5/16"xOD18x2t	2	31E	PDCPF22201-31E	HEX BOLT M5*10mm	16
23I	PDCPF22201-23I	HEX LOCK NUT 5/16"	1	31F	PDCPF22201-31FV2	COVER PLATE RIGHT V2.2021	1
24	PDCPF22201-24	HEPA FILTER Ø400mm x 900mm L	1	31G	PDCPF22201-31GV2	COVER PLATE LEFT V2.2021	1
24A	PDCPF22201-24AV2	HEPA END CAP V2.2021	1	31H	PDCPF22201-31H	HEX BOLT 1/4"*3/4"	6
31I	PDCPF22201-31I	FLAT WASHER 1/4"*OD19*1t	6	43C	PDCPF22201-43C	ROUND HEAD BOLT M4*10mm	6
31J	PDCPF22201-31J	CANISTER FILTER SHIELD	1	43D	PDCPF22201-43D	PHILIP HD BOLT M4*6mm	4
31K	PDCPF22201-31K	HEX BOLT 1/4"*3/4"	4	43E	PDCPF22201-43E	BUZZER SUPPORT PLATE	1
31L	PDCPF22201-31L	FLAT WASHER 1/4"*OD19*1t	4	43F	PDCPF22201-43F	PHILIP HD BOLT M4*6mm	2
32	PDCPF22201-32V2	DRUM INSERT V2. 2021	4	43G	PDCPF22201-43G	BUZZER/ALARM	1
33	PDCPF22201-33	MOTOR BASE COVER PLATE	1	44	PDCPF22201-44	PHILIP HD BOLT M4*6mm	4
34	PDCPF22201-34	RIVET	40	45	PDCPF22201-45	RUBBER HANDLE FOR DRUM INSERT	4
34C	PDCPF22201-34C	RIVET NUT 1/4"	8	46	PDCPF22201-46	CONTROL PANDLE HANDLE	2
34D	PDCPF22201-34D	RIVET NUT 5/16"	18	46A	PDCPF22201-46A	PHILIP HD BOLT M4*6mm	4
35	PDCPF22201-35	SHEET METAL BOLT 3/16"*1/2"	24	47	PDCPF22201-47	CROSSBAR	1
35A	PDCPF22201-35A	NUT 3/16"	24	48	PDCPF22201-48	SILICONE	1
42	PDCPF22201-42	JUNCTION BOX	1	49	PDCPF22201-49	LED WINDOW	1
42A	PDCPF22201-42A	JUNCTION BOX PLATE	1	49A	PDCPF22201-49A	RIVET 3-2	2
42B	PDCPF22201-42B	PHILIP HD BOLT M4*6mm	4	50	PDCPF22201-50	LED LIGHT	1
42C	PDCPF22201-42C	HEX BOLT 1/4"x3/4"	2	51	PDCPF22201-51	LED LIGHT COVER	1
42D	PDCPF22201-42D	FLAT WASHER 1/4"XOD19x2t	2	51A	PDCPF22201-51A	PHILIP HD BOLT M4*10mm	6
43	PDCPF22201-43V2	CONTROL BOX V2.2021	1	51B	PDCPF22201-51B	FLAT WASHER 3/16"*OD12*1t	6
43A	PDCPF22201-43AV2	CONTROL PANEL V2.2021	1	51C	PDCPF22201-51C	HEX NUT M4	6
43B	PDCPF22201-43BV2	CONTROL PANEL SUPPORT PLATE V2.2021	1				